



# LIFESAVER

## Photoelectric Smoke Alarm

### MODEL 6000

- 240VAC with 9VDC battery backup

### MODEL 6000RL

- 240VAC with built-in rechargeable battery backup

240VAC mains powered standalone and / or interconnectable (24 units) photoelectric smoke alarm.

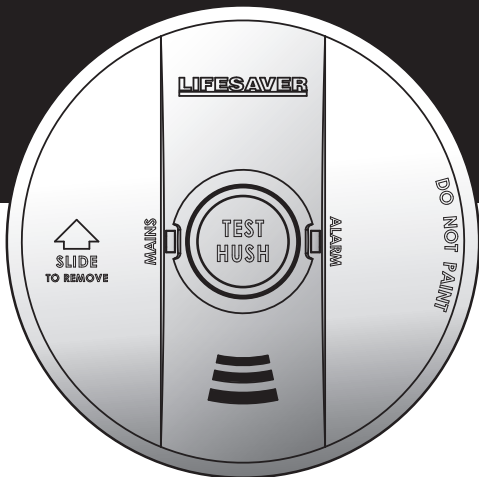

Tested & Complies to  
Australian Standards  
AS3786:2014



Australian  
Standard  
AS3786:2014  
Lic:SMK1377  
SAI Global

Part Number:  
LIF6000  
LIF6000RL

# Thank You for Purchasing this PSA Lifesaver Smoke Alarm

**NOTE: Please thoroughly read this user guide and save the document for future reference and to pass on to any subsequent owner. Important: Please read this user guide before installation.**

Teach children how to respond to the alarm and that they should never play with the unit. Your PSA LIFESAVER Smoke Alarm is designed for use in a residential environment. It is not designed for use in a recreational vehicle (RV) or boat.

**IMPORTANT: Additional markings can be found on the back of the unit.**

Product Support: 1300 772 776

*Please write down the below information and have this at hand when you call.*

Model: \_\_\_\_\_

Date Code (on back): \_\_\_\_\_

Date of Purchase: \_\_\_\_\_

Where Purchased: \_\_\_\_\_

Date to Replace: \_\_\_\_\_

# Contents

1. Smoke Alarm: What To Do When The Alarm Sounds .....	4
2. Product Features And Specifications .....	5
3. Recommended Locations For Alarms .....	6
4. Locations To Avoid .....	8
5. Installation Instructions .....	9
6. Mounting Instructions .....	13
7. Battery Installation, Replacement and Test.....	15
8. Operating and Testing .....	17
9. Visual And Audible Indications .....	19
10. 9V Terminal and Smoke Alarm Remote Control .....	21
11. Nuisance Alarm And HUSH .....	23
12. Maintenance .....	24
13. Good Safety Habits .....	25
14. Limitations Of Smoke Alarms .....	26
15. Warranty and Liability.....	27
16.Product warranty registration.....	28

# 1. Smoke Alarm: What To Do When the Alarm Sounds

Smoke alarm pattern is three long beeps, a 1.5 second pause, and three long beeps repeating. The red LED flashes every second during alarm.

- Alert small children in the home as well as anyone else who may have difficulty recognising the importance of the alarm sounding or who may have difficulty leaving the area without help.
- Leave immediately by your escape plan. Every second counts, so don't waste time getting dressed or picking up valuables.
- In leaving, don't open any inside door without first feeling its surface. If hot, or if you see smoke seeping through cracks, don't open that door! Instead, use your alternate exit. If the inside of the door is cool, place your shoulder against it, open it slightly and be ready to slam it shut if heat and smoke rush in.
- If the escape route requires you to go through smoke, stay close to the floor where the air is cleaner. Crawl if necessary, and breathe shallowly through a cloth, wet if possible.
- Once outside, go to your selected meeting place and make sure everyone is there.
- Call the fire department from your mobile phone outside, or from your neighbour's home-not from yours!
- Don't return to your home until the fire officials say that it is all right to do so.
- There are situations where a smoke alarm may not be effective to protect against fire.  
For instance:
  - a) smoking in bed
  - b) leaving children home alone
  - c) cleaning with flammable liquids, such as petrol or methanol

## 2. Product Features And Specifications

This alarm detects particles of combustion using photoelectric technology. This smoke alarm has an expected service life of ten years under normal conditions. We recommend that you should replace after 10 years from installation date to ensure normal operation.

### Product Features and Specifications:

- MODEL 6000: Powered by 240VAC (50Hz, 10 mA max, 4mA standby) hardwire with 9V replaceable battery backup
- MODEL 6000RL: Powered by 240VAC (50Hz, 10 mA max, 4mA standby) hardwire with built-in rechargeable battery backup
- Temperature: Operating Range: 0 °C to 40 °C
- Humidity: Operating range: up to 93% RH non-condensing
- Audible Alarm: 85+ dBA at 3m @ 3.0 to 3.5 KHz pulsing alarm
- Smoke Sensor: Photoelectric
- Smoke Alarm HUSH® Control
- Storage and Transport Conditions: -20° C to +60° C, 5-95%RH (non-condensing)
- Interconnectable up to 24 units
- Insect mesh protection over sensor.
- Quick slide base plate for easy installation
- Low battery hush for 8 hours.
- Initiating alarm memory feature.
- Chamber fault monitoring
- Approved to AS3786:2014 Australian Standard

### 3. Recommended Locations For Alarms

- Check specific State legislation in your area to ensure smoke alarms are correctly located according to local laws. Each State or Territory may differ in building codes and regulations. PSA Products can only recommend the locations.
- Locate an alarm for each separate sleeping area in the immediate vicinity of the bedrooms. Try to monitor the exit path as the bedrooms are usually farthest from an exit. If more than one sleeping area exist, then install additional alarms in the immediate vicinity of each sleeping area.
- Locate additional alarms to monitor any stairwells because stairwells act like chimneys for smoke and heat.
- Locate at least one alarm on every floor level.
- Locate an alarm in every room where a smoker sleeps.
- Locate an alarm in every room where electrical appliances are operated (i.e. portable heaters or humidifiers).
- Locate an alarm in every room where someone sleeps with the door closed. The closed door may prevent an alarm not located in that room from waking the sleeper.
- Smoke, heat and other combustion products rise to the ceiling and spread horizontally. Mounting the alarm on the ceiling in the center of the room places it closest to all points in the room. Ceiling mounting is preferred in ordinary residential construction..
- When mounting alarms on the ceiling locate it at least 300mm away from the side wall and 300mm away from any corner. (see diagram).
- When mounting alarms on a wall, use the inside wall. The recommended position is between 300mm and 500mm off the ceiling. (see diagram).

**NOTE: The performance of smoke alarms mounted on walls is unpredictable and this mounting position is not recommended when ceiling mounting can be implemented.**

## Location of smoke alarm

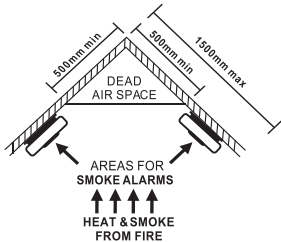

Apex Of Sloping Ceiling

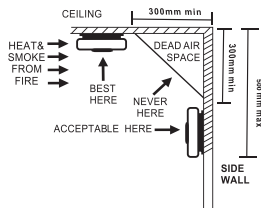

Ceiling / Wall Junction

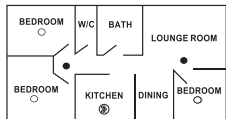

- Smoke alarms for minimum protection
- Smoke alarms for additional protection
- Ⓜ Heat alarms for additional protection

Single Floor

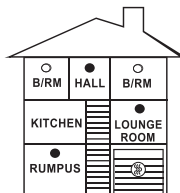

Typical Multiple Floor Installation

**IMPORTANT:** incorrect orientation of smoke alarm may decrease operational effectiveness

## 4. Locations To Avoid

- Do not locate your smoke alarm in the garage - products of combustion are present when you start your automobile. Use Lifesaver Heat Alarm in this location.
- Do not locate your smoke alarm in front of forced air supply ducts used for heating and air conditioning and other high air flow areas.
- Do not locate your alarm less than 500mm from the peak of an "A" frame type ceiling.
- Do not locate your alarm in areas where temperatures may fall below 0°C or rise above 40°C, or in humidity higher than 93% as these conditions may reduce battery life.
- Avoid dusty areas, dust particles may cause smoke alarm to false alarm or fail to alarm. Use Lifesaver Heat Alarm in this location to avoid false alarms.
- Avoid very humid areas or near a bathroom, moisture can cause false alarm.
- Avoid insect-infested areas.
- Do not locate alarm within 0.9m of the following: the door to a kitchen, the door to a bathroom containing a tub or shower, ceiling or whole house ventilating fans, or other high flow areas.
- Avoid locating near fluorescent lights or other electrical equipment. Electronic magnetic interferences or "noise" may cause nuisance alarms or chirping. Install smoke alarms at least 300mm away from lights and other electrical devices.



## 5. Installation

**THIS SMOKE ALARM MUST BE INSTALLED BY QUALIFIED (LICENSED) ELECTRICIANS ONLY.**

### Wiring Requirements

- All connections must be installed by a qualified electrician and be in accordance with the relevant requirements of the SAA Wiring Rules AS 3000 Standards.
- The appropriate power source is 240V AC 50Hz continuous single phase sine wave current supplied from a non-switchable circuit.
- Smoke alarms are not to be used with detector guards unless the combination (alarm and guard) has been evaluated and found suitable for that purpose.

**⚠ WARNING: This alarm cannot be operated from power derived from a square wave or modified square wave inverter. These type of inverters are sometimes used to supply power to the structure in off-grid installations, such as solar or wind derived power sources. These power sources produce high peak voltages that will damage the alarm.**

### Wiring instructions for Ceiling Baseplate

**⚠ CAUTION! TURN OFF THE MAIN POWER TO THE CIRCUIT BEFORE WIRING THE ALARM.**

- For smoke alarms that are used as STANDALONE units, LEAVE THE SWITCH WIRE UNCONNECTED.
- When alarms are interconnected, all interconnected units must be powered from a single circuit.
- A maximum of 24 PSA LIFESAVER devices may be interconnected by hardwire.

**Note:** Use approved listed Australian Standards cable 1.0mm<sup>2</sup> TPS or larger as required by local codes.

**Terminals at back of mounting base are marked as follows:**

**ALARM ----- CONNECTED TO:**

9V ----- 9V (9V DC Positive Power Source)

A ----- A (Active Side of AC Line)

SW ----- SW (Switch wire for interconnection only)

N ----- N (Neutral Side of AC Line)

LOOP ----- Loop dead terminal

**⚠ WARNING:** Connecting the Switch wire terminal to any other supply conductor may result in damage to the alarm, failure to operate or shock hazard and void the warranty of the alarm.

- When interconnected, all Smoke Alarms will sound upon activation.
- This Smoke Alarm can only interconnect with other PSA LIFESAVER models of Smoke Alarms, Heat alarms, CO alarms; whether of Ionisation or Photoelectric design. Interconnection with other brands may cause damage or result in electric shock or fire risk.

**Note:** For interconnection of smoke alarms to Fire Panel or Auxiliary devices, use only LIFESAVER Isolation Relay Model LIFSAIR or LIFSAIRMB.

**FIGURE 1**

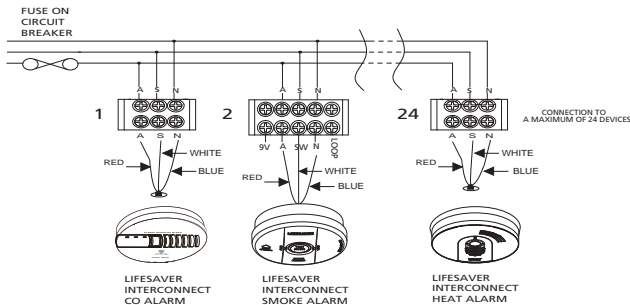

- **For model 6000RL;**

Connecting the smoke alarm on the base plate will activate the battery. Please note, the long absence of mains power may damage the rechargeable battery. Warranty is void if the battery is damaged. If the mains power is turned off for a long period of time, for example, if the building is not occupied, disconnect the smoke alarm from the base plate. When mains power is turned on, ensure the smoke alarm is then connected to the base plate. The battery may be low in new smoke alarms, please allow up to 8 hours for the battery to fully charge. Smoke alarms may chirp until the battery is fully charged.

- This Smoke Alarm can only interconnect with PSA Products LIFESAVER range of smoke alarms, heat alarm and accessories. Interconnection with other brands may cause damage or result in a shock or fire risk and void warranty.
- Due to “noise” from electromagnetic interference, up to 24 units of smoke alarms and compatible products may be interconnected.
- There are five terminals in the supply terminal block, marked 9V, A, SW, N, LOOP. It is important that the alarm be wired correctly to ensure correct operation. Incorrect wiring to the smoke alarm will damage the unit and void the warranty.
- A total maximum of 250 meters (820 feet) of wire can be used in interconnecting smoke alarms.
- Smoke Alarms can be wirelessly interconnected using a wireless baseplate Model 6000WB. Using the wireless baseplate will not require the SW terminal to be connected.
- Smoke alarms interconnected using the wireless baseplate 6000WB can be wired to different 240VAC power circuits.

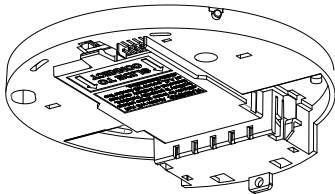

Model 6000WB

- Hardwired interconnected Smoke Alarms must be connected to the same electrical subcircuit.
- Do not use any coloured wire for the interconnection cable that could be confused with normal electrical cables. For example, green/yellow Earth wire.
- Do not connect AC power wires to SW interconnect terminal. These will damage smoke alarms.
- Do not connect the SW interconnect wire to any device, except the SW interconnect terminal of smoke alarm. Otherwise, the smoke alarm will be damaged.
- Do not connect 9V wire to AC power or SW interconnect terminal. This will damage the smoke alarms.
- Smoke alarms should be interconnected only within the confines of a single family living unit. If smoke alarms are interconnected between different units, there may be excessive nuisance alarms. Residents may not be aware that smoke alarms are being tested or that it is a nuisance alarm caused by cooking, etc.
- Smoke alarms must be installed in their own electrical subcircuit to avoid false alarms and nuisance chirping that may be caused by electromagnetic interferences from other electrical equipment.
- Do not install a smoke alarm in the same subcircuit as electrical equipment likely to produce electrical noise and interference to the mains supply. Eg. airconditioners, fans, heat lamps, and lighting dimmers.

## 6. Mounting Instructions

### To mount the smoke alarm:

1. Separate the Smoke Alarm from its mounting base - by sliding the Smoke Alarm in direction of arrow, while holding the back of the mounting base (See Figure 2).

**NOTE:** AC power should be turned off at this stage.

2. Connect supply cable to terminal block and fix terminal cover. Install the mounting base to the ceiling or wall.
3. Align and slide smoke alarm up onto mounting base (Figure 3) then slide in the reverse direction of arrow to ensure proper connection.
4. Switch on power and check the green LED. It should be lit when mains power is switched on indicating that the smoke alarm is properly connected to the mounting base.
5. Secure Tamper Locking screw (supplied) to smoke alarm if required (see Figure 3).
6. Test the Smoke Alarm by pressing Test button.

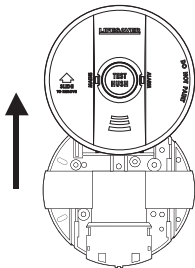

**Figure 2:** To remove smoke alarm

Slide smoke alarm carefully away from the base plate to remove the smoke alarm.

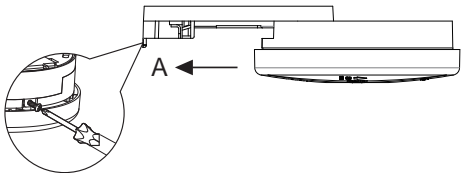
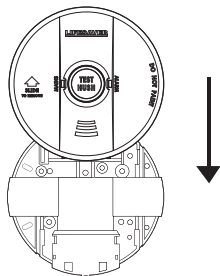

**Figure 3:** To connect smoke alarm

1. Place smoke alarm in line with the base plate.
2. Push smoke alarm towards connector (A). Ensure the smoke alarm slides fully into the connector.
3. Green AC power light will come on when connected to mains.

#### Figure 4: Wall mounting smoke alarm

For wall mounting, the connector must be at the bottom. Ensure " SLIDE TO REMOVE " arrow on the Smoke Alarm is pointing upwards (vertical) as shown.



#### Remove smoke alarm from base plate

**NOTE: AC power should be turned off at this stage.**

1. Look for 'SLIDE TO REMOVE'.
2. Remove tamper locking screw if installed (see Figure 3).
3. Push firmly in direction of arrow until smoke alarm is free from its base plate.
4. To re-install smoke alarm follow the steps on page 10.

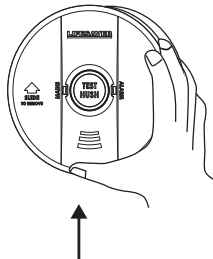

**Remove smoke alarm**

Slide smoke alarm cover in direction of arrow (as shown on cover) to remove from base plate

# 7. Battery Installation, Replacement and Test

## Battery Installation for Model 6000

- This model uses one 9V battery to automatically provide backup power to the alarm if AC power fails. A fully charged 9V battery will operate the smoke alarm for one year with AC power off.
- The smoke alarm has a low battery indicator that will cause the unit to chirp at approximately 40 second intervals for a minimum of 30 days. Missing battery with main power connected will cause the unit to chirp at approximately 40 second intervals.
- Replace battery when chirping occurs. To ensure proper operation, the battery should be replaced once a year.
- To replace battery, remove alarm from mounting base (see section 6) and remove the battery from compartment. Replace the old battery with a new one.
- The smoke alarm has a low battery hush feature. When the smoke alarm emits a low battery chirp, pressing the Hush button will silence or snooze the low battery chirp for 8 hours.

### USE ONLY THE FOLLOWING 9-VOLT ALKALINE BATTERIES FOR REPLACEMENT:

#### ENERGIZER 522; DURACELL MN1604, MX1604

These batteries can be purchased at your local retail outlet or supermarket.

**⚠ Caution: Use only specified batteries. Use of different battery may have a detrimental effect on operation or may cause the battery to explode resulting in injury or fire.**

- Fold Red Battery Lever down into compartment with fresh replacement battery. If the Red Battery Lever is not held down in the battery compartment by the battery, the smoke alarm will not close and will not be operational. Battery can only be inserted in one direction, ensure polarity is correct.

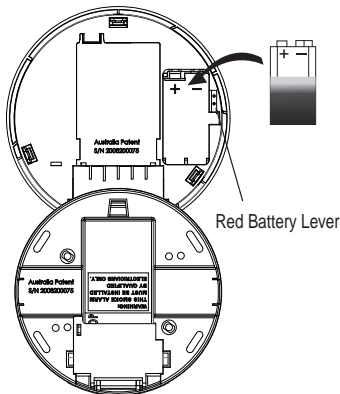

## **Battery Test:**

- Switch off mains power. The Green LED on the smoke alarm will be OFF.
- Test alarm by pressing on the Test Button for a few seconds. This should sound the alarm.
- If the battery module has a fault, the alarm will chirp every 40 seconds.
- Watch the Red LED for about 5 minutes. It should flash at least once.
- Switch on mains power only when smoke alarm passes the above tests. The Green LED on the smoke alarm will come ON.

## **For Model 6000RL Only**

- The Rechargeable battery must be checked periodically. We recommend a weekly battery test.
- Smoke alarm must be connected to mains power for 8 hours for the battery to be fully charged.
- If the premises is without mains power for an extended period of time, such as a vacation home where the mains power is turned off when it is not occupied, it is recommended to disconnect the smoke alarm from the baseplate to prevent damage to the battery. Re-connect the smoke alarm to the baseplate when mains power is turned on.
- If the battery is low, the Red LED will flash every 40 seconds and sound a chirp. We recommend that you check the AC mains power and allow up to 8 hours to fully recharge the battery. If chirping continues even after sufficient charging, we recommend you replace the smoke alarm.
- The rechargeable battery will provide backup to the smoke alarm for 6 months without AC power. And if the smoke alarm is connected to an ancillary base, it will provide backup for 2 months without AC power. Under normal conditions, the battery has a life of 10 years.
- Rechargeable backup battery will only operate when the smoke alarm is connected to the baseplate. Removing the smoke alarm from the baseplate will render the smoke alarm inoperative.



## 8. Operating and Testing

### Operation

The smoke alarm is operational once all wires are properly connected, a fresh battery is installed and the battery activate tab is pulled out (Model 6000), the smoke alarm is correctly installed on the mounting base and the alarm has been tested.

**There are two LED indicators. Each of them has a unique function:**

This smoke alarm features a red and green LED indicator.

The LEDs indicate the following:

#### Red LED

**Standby mode:** The Red LED will flash once every 5 minutes (approx.) to indicate the unit is functioning properly.

**Alarm mode:** The Red LED will flash when unit goes into alarm, indicating that products of combustion have been detected. The flashing Red LED and three beeps (loud 85dBA at 3m) will continue until the air is cleared. For interconnected units, the originating smoke alarm Red LED will flash every second. All other units will sound but their Red LEDs will not flash.

#### Green LED

**AC Mains-ON Indicator:** Indicates the unit is operating on AC power. If this LED is Off, it indicates loss of AC power.

## Testing the Smoke Alarm

**⚠ WARNING: Test each smoke alarm and heat alarm to ensure they have been correctly installed and are operating properly.**

Stand at arm's length from the smoke alarm when testing. The alarm sounder is intentionally loud to alert you of any emergencies; and thus can be harmful to your hearing.

Test the smoke alarm monthly and upon returning from holiday, or when the house has been unoccupied for several days.

### **Test all alarms monthly by doing the following:**

1. Ensure the green LED next to the Test/Hush button is ON. This confirms the smoke alarm is receiving AC power.
2. Press and hold the TEST/Hush Button for at least five (5) seconds. The smoke alarm will sound the following repeating pattern: 3 long beeps, pause, then another 3 long beeps. This continues up to 10 seconds after the Button is released.  
**Note:** If the smoke alarms are interconnected, all smoke & heat alarms should sound an alarm within three (3) seconds after any Test Button is pressed.
3. If the smoke alarm does not sound, please refer to Section 9: Visual And Audible Indications. If the issue is unresolved, please contact PSA Technical Support for assistance.

## 9. Visual And Audible Indications

The following tables describes visual and audible indications the unit may emit during normal operation.

Mode	LED Indications	Audible Indications	Note:
Normal	Green LED steady ON	None	Green LED indicates AC Mains power is present.
Normal	Red LED flashes every 5 minutes.	None	A single Red LED flash every 5 minutes indicates normal condition. This follows successful self test every 5 minutes. The battery and electronics are tested for the life of the unit.
Alarm mode (initiating unit)	Red LED flashing continuously..	Repeat 3 long beeps(ISO8201)	Indicates the smoke alarm is in alarm mode, and this unit is the source of the alarm activation.
Alarm mode (Interconnected units)	Red LEDs remain OFF	Repeat 3 long beeps(ISO8201)	This unit is in full alarm. However the alarm was raised by another interconnected unit. Check the other smoke alarms & devices.
Hush mode	Red LED flashes once every 10 seconds	None	Hush Button has been pressed. Smoke Alarm will silence for about 9 minutes, and then automatically exit Hush mode.
Smoke Alarm Memory (initiating unit)	Red LED flashes three times every 40 seconds.	Rapid chirps while Test Button is pressed.	While the Test Button is pressed, the Smoke Alarm will chirp rapidly, and the red LED will flash. When the Button is released, the Alarm Memory will reset. This feature identifies the initiating smoke alarm. Note: All other units will simply go into normal Test Mode.

Mode	LED Indications	Audible Indications	Note:
Low Battery	Red LED flashes every 5 minutes	Single chirp every 40 seconds	For 6000 model, replace the 9V battery. For 6000RL model, replace with new smoke alarm.
Low Battery Hush	Red LED flashes every 5 minutes	None	Pressing the Hush button during low battery chirp will silence the low battery chirp for up to 8 hours. For model 6000, replace the battery. For model 6000RL, replace with new smoke alarm.
Chamber Fault	Red LED flashes every 5 minutes	Three chirps every 40 seconds	Clean the alarm with a vacuum cleaner or compressed air. If the fault condition persists, please replace with new smoke alarm.

# 10. 9V Terminal and Smoke Alarm Remote Control

## 9V Terminal

**⚠ WARNING: THIS TERMINAL IS NOT ISOLATED FROM THE MAINS SUPPLY.**

This 9V terminal is a 9V DC positive output and can be used for the following applications:

1. As an output to operate the smoke alarm as part of an early warning system.

The 9V terminal in this smoke alarm is intended for use with a security/fire alarm panel where a signal from that panel can be used to activate a single Smoke Alarm or interconnected Smoke Alarms to alert residents/occupants that an alarm has been activated elsewhere and there may be cause to evacuate the area.

2. To provide power to ancillary devices.

Connecting the 9V, SW and N terminals to the smoke alarm isolation relay LIFSAIR or LIFSAIRMB allows the smoke alarm to activate devices such as emergency exit lights, sirens, strobes, bells, or exhaust fans which do not exceed 240AC @ 5A. Refer to the diagram below.

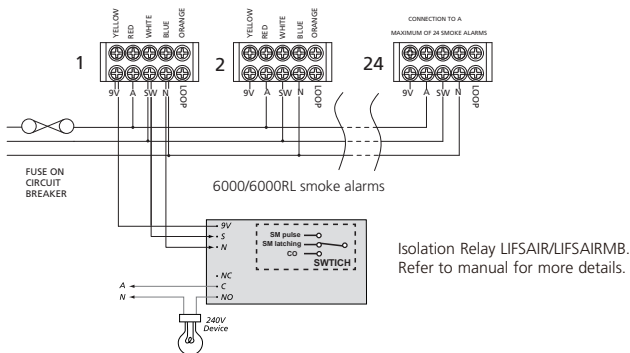

- Secondary Contacts NO and NC are activated by smoke alarm interconnect switch wire
- Contacts are rated 240V AC 5Amps

## Smoke Alarm Remote Control

The LIFESAVER 6000 series smoke alarms can be wirelessly controlled with a Smoke Alarm Remote Control Model 6000THL. The Remote Control can TEST, LOCATE and HUSH the smoke alarms. Smoke Alarms Model 6000 and 6000RL require a wireless base (Model 6000WB) to enable this feature.

*6000DCW, 6000 and 6000RL smoke alarm,  
6000WB wireless base.*

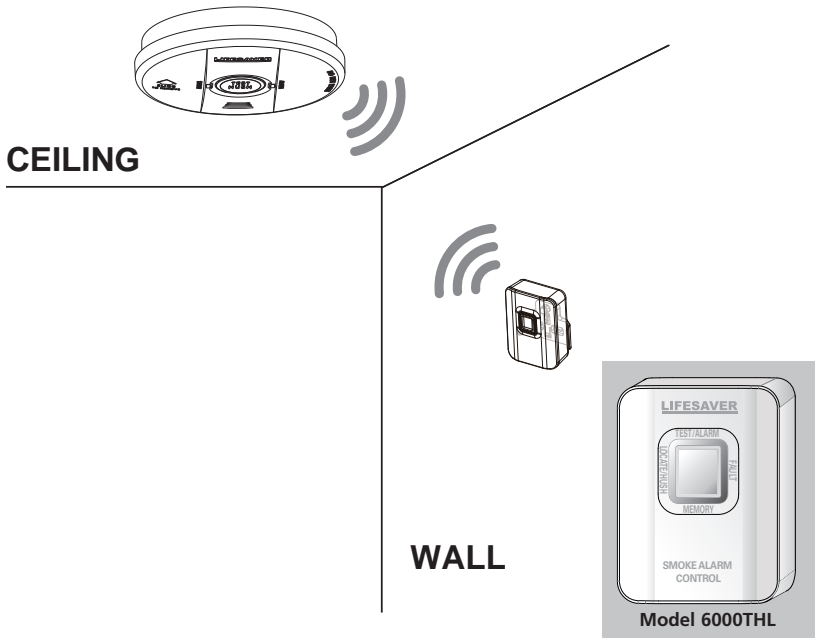

## 11. Nuisance Alarm And HUSH

This alarm is designed to minimise nuisance alarms. Cigarette smoke will not normally cause the unit to alarm, unless the smoke is blown directly into the alarm. Combustion particles from cooking may set off the alarm if it is located too close to a cooking appliance. Large quantities of combustible particles are generated from spills or when broiling. Using the fan on a range hood which vents to the outside (non-recirculating type) will also help prevent nuisance alarms from occurring by removing these combustible products from the kitchen.

### HUSH

If you know why the alarm is sounding, and have verified that it is not a life threatening situation, you can push the “TEST AND HUSH” button initiating unit. This will silence the smoke alarm, and make the Red LED flash once every 10 seconds, for up to 9 minutes. If the smoke is not too dense, that unit and all interconnected units will silence. After the Hush period, the smoke alarm will automatically reset and sound the alarm if particles of combustion are still present. You can use Hush repeatedly until the air has been cleared of the condition causing the alarm.

Note: Dense smoke will override this Hush mode and sound a continuous alarm. If no fire is present, check to see if one of the reasons listed in Section 4. LOCATIONS TO AVOID may have caused the alarm. If a fire is discovered, evacuate and call the fire department.

- Pushing the button on the initiating smoke alarm will silence that alarm and all compatible interconnected units.
- Pushing the button on any non-initiating hardwired alarm will not silence an alarm in an interconnected system.

### Smoke Alarm Memory

This smoke alarm has a memory function that can identify if the smoke alarm was the initiating unit since the TEST button was last pressed. Pressing the TEST button will cause the smoke alarm to chirp rapidly and the red LED to flash rapidly. The alarm memory is reset when the TEST button is released. This feature can be used after an alarm event, if the initiating smoke alarm had not been silenced by the Hush Button.

### Low Battery Hush

The smoke alarm has a low battery hush feature. When the smoke alarm chirps to indicate a low battery condition, pressing the Hush button on that smoke alarm will silence the low battery chirp for 8 hours. This user friendly feature allows the smoke alarm to delay the low battery chirp for 8 hours until it can be attended to at a more convenient time. The smoke alarm will still operate as normal if it detects the presence of a fire.

## 12. Maintenance

### **YOUR SMOKE ALARM SHOULD BE CLEANED AT LEAST ONCE A YEAR.**

To clean your smoke alarm, first remove it from the mounting base as outlined in Section 6. Clean the smoke alarm with compressed air or a vacuum cleaner; by blowing or vacuuming through the vent openings around the rear rim of the smoke alarm. The outside shell of the smoke alarm can be wiped with a damp cloth.

After cleaning, reinstall your alarm back on the mounting base and test your alarm by using the Test Button. If cleaning does not restore the alarm to normal operation, the alarm should be replaced.

**⚠ WARNING : Reinstall the Alarm as soon as possible to ensure continuous protection.**

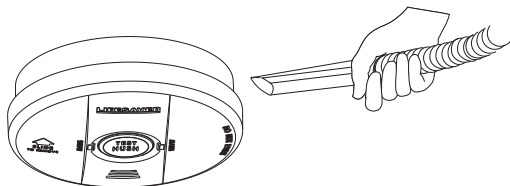

Please note: False alarms activated by contaminants such as dust and insects inside the smoke alarm are not covered under warranty. Please ensure the smoke alarms are properly maintained and cleaned regularly.

### **Smoke Chamber Monitoring**

The smoke alarm constantly monitors the condition of the smoke chamber. If the chamber detects a build up of dust and contaminants, it will chirp 3 times every 40 seconds and the red LED will flash every 5 minutes. This indicates the smoke chamber requires cleaning. The smoke alarm will operate as normal in an event of a fire. However, the chance of a false alarm is high. If the fault remains after cleaning, then please replace the smoke alarm.



# 13. Good Safety Habits

## DEVELOP AND PRACTICE AN ESCAPE PLAN

- Install and maintain Fire extinguishers on every level of the home, in the kitchen, basement and garage. Know how to use a fire extinguisher prior to an emergency.
- Make a floor plan indicating all doors and windows and at least two (2) escape routes from each room. Second story windows may need a rope or chain ladder.
- Have a family meeting and discuss your escape plan, showing everyone what to do in case of fire.
- Determine a place outside your home where you all can meet if a fire occurs.
- Familiarise everyone with the sound of the smoke alarm and train them to leave your home when they hear it.
- Practice a fire drill at least every six months, including fire drills at night. Ensure that small children hear the alarm and wake when it sounds. They must wake up in order to execute the escape plan. Practice allows all occupants to test your plan before an emergency. You may not be able to reach your children. It is important they know what to do.

## RECOMMENDATIONS

### Do I Need More Smoke Alarms?

The required number of smoke alarms might not provide reliable warning for areas separated by a door from the protected areas with smoke alarms.

For this reason, we recommend the householder to consider installing additional smoke alarms for increased protection. These additional unprotected areas include the basement, bedrooms, dining room, utility room, and hallways.

It is not recommended for smoke alarms to be installed in the kitchen, attic or garage; as these locations can experience conditions that would result in improper operation.

## 14. Limitations Of Smoke Alarms

### **WARNING: PLEASE READ CAREFULLY AND THOROUGHLY.**

- Fire safety in residential occupancies is primarily based on providing early warning to the occupants of the need to evacuate the building. This must be followed by their appropriate actions. Fire warning systems for dwelling units are capable of protecting about half of the occupants in potentially fatal fires. Victims are often either trapped by the fire, too old or young, physically or mentally impaired, such that they cannot escape even when early warning was given. For these people, other strategies such as assisted escape or rescue are necessary.
- Smoke alarms must be tested regularly to ensure the batteries and the alarm circuits are in good operating condition.
- Smoke alarms cannot provide an alarm if smoke does not reach the alarm. Therefore, smoke alarms may not sense fires that have started in chimneys, walls, on roofs, on the other side of a closed door or on a different floor.
- If the alarm is located outside the bedroom or on a different floor, it may not wake up a sound sleeper.
- The use of alcohol or drugs may also impair one's ability to hear the smoke alarm. For maximum protection, a smoke alarm should be installed in each sleeping area on every level of a home.
- Although smoke alarms can help save lives by providing an early warning of a fire, they are not a substitute for an insurance policy. Home owners and renters should have adequate insurance to protect their lives and property.

## 15. Warranty and Liability

1. PSA Products Pty Ltd (ABN: 99 076 468 703) of 17 Millicent Street, Burwood 3125 Victoria, Australia warrants the model 6000 and model 6000RL for a period of five (5) years from the date of purchase, as reflected on the Authorised Reseller's or Distributor' invoice / receipt provided to you. PSA Products Pty Ltd will repair or replace the product (at the option of PSA Products) due to any manufacturing defect, at the cost of PSA Products Pty Ltd (excluding any labour costs relating to removal or re-installation of product, and transport costs).
2. This warranty shall not apply to the product if it has been damaged, modified, insect infested, contaminated, abused or altered after the date of purchase, or if it fails to operate due to improper maintenance.
3. To the extent permitted by law, the liability of PSA Products Pty Ltd arising from the sale or under the terms of this limited warranty shall not in any case exceed the cost of replacement and subject to this clause. In no case shall PSA Products Pty Ltd be liable for consequential loss or damages resulting from the failure of the product or breach of this, or: Any other warranty, express or implied, loss or damage caused by failure to abide by the instructions supplied in the leaflets.
4. To the extent permitted by law, PSA Products Pty Ltd., makes no warranty, expressed or implied, written or oral, including that of merchantability or fitness for any particular purpose, with respect to the consumer replaceable battery if any. A product with non-serviceable built-in battery is covered under warranty of the product.
5. This warranty is provided in addition to other rights and remedies you have under law: Our goods come with guarantees that cannot be excluded under the Australian Consumer Law. You are entitled to a replacement or refund for a major failure and compensation for any other reasonably foreseeable loss or damage. You are also entitled to have the goods repaired or replaced if the goods fail to be of acceptable quality and the failure does not amount to a major failure. What constitutes a major failure is set out in the Australian Consumer Law.
6. To make a claim under warranty, take the product (with a proof of purchase) to the store where you purchased the product or contact PSA Products Pty Ltd. Phone (03) 9888 9889. or Email: [enquiry@psaproducts.com.au](mailto:enquiry@psaproducts.com.au) with details, proof of purchase or expense claim in writing.

## 16. Product warranty registration

Thank you for purchasing and installing the most trusted brand in fire, security and intercoms. To ensure you receive excellent after-sale product service we encourage you to register your products. There are a few important reasons to register your product:

1. It will ensure your investment is protected in case it is damaged or broken and we can effectively carry out any warranty claims.
2. Registration will also allow us to contact you in an unlikely event of product safety notification required under Consumer Product Safety Act.
3. Registration will also help us improve our product design to meet your needs.

Register at: <https://www.psaproducts.com.au/register-product/>

Register this product for warranty to ensure fast and effective service.

Otherwise, please retain this warranty section and complete the details below. When you claim Warranty for the product please present this section together with the faulty product.

Model: \_\_\_\_\_ Serial Number: \_\_\_\_\_

Date Of Purchase/ Installation: \_\_\_\_\_ Invoice No: \_\_\_\_\_

Installed By: \_\_\_\_\_

Owner's Details: \_\_\_\_\_

**This smoke alarm has an expected service life of 10 years under normal conditions. We recommend that you should replace the smoke alarm after 10 years from installation date to ensure normal operation.**

THIS SMOKE ALARM HAS BEEN TESTED AND COMPLIES TO AS3786:2014

DEAR INSTALLER:  
PLEASE LEAVE THIS MANUAL FOR THE OWNER.  
THANK YOU FOR CHOOSING THIS SMOKE ALARM.



Tested & Complies to  
Australian Standards  
AS3786:2014



Australian  
Standard  
AS3786:2014  
Lic:SMK1377  
SAI Global



*Another Quality Product By:*

**PSA Products Pty Ltd**

17 Millicent Street, Burwood, Victoria 3125, Australia

Ph: 03 9888 9889

Email: [enquiry@psaproducts.com.au](mailto:enquiry@psaproducts.com.au)

Website: [www.psaproducts.com.au](http://www.psaproducts.com.au)



*Manufactured under ISO standard  
Quality Approved Manufacturing*



# **LIFESAVER**

## **Smoke Alarm**

Mains powered smoke alarm with 9V battery (6000)

Mains powered smoke alarm with rechargeable lithium battery (6000RL)

Battery 10 year smoke alarm wireless interlink (6000DCW)

Mains powered smoke alarm with 9V battery (HG3000)

Battery 10 year mini smoke alarm (LIFPE10)

Battery 9V smoke alarm (LIFPE9M)

## **Carbon Monoxide Alarm**

Mains powered CO alarm with rechargeable lithium battery (LIFCO240)

Battery powered CO alarm (LIFCO9D)

## **Heat Alarm**

Mains powered heat alarm with 9V battery (LIFHA240)

## **Ancillaries**

Wireless remote smoke alarm controller (6000THL)

Wireless interconnect base plate (6000WB)

Isolation relay (LIFSAIR, LIFSAIRMB)

Surface mounting block (LIFMB3848)

Smoke detector tester (LIFLT711)

Fire blankets and extinguishers

## **Security & Intercom Products**

Security alarm systems

CCTV systems

WIFI cameras and security products

Audio & Video intercom systems

Door Access control systems